

Resilient Sound Isolation Wall and Ceiling Clip

Model IsoMax

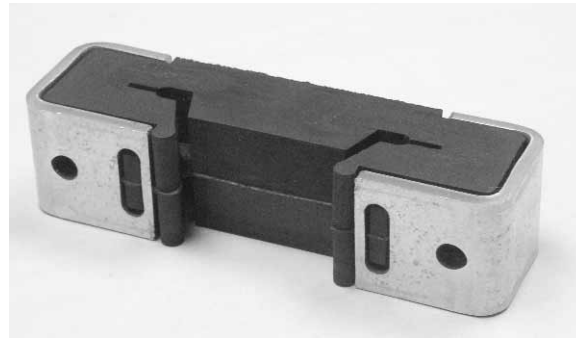
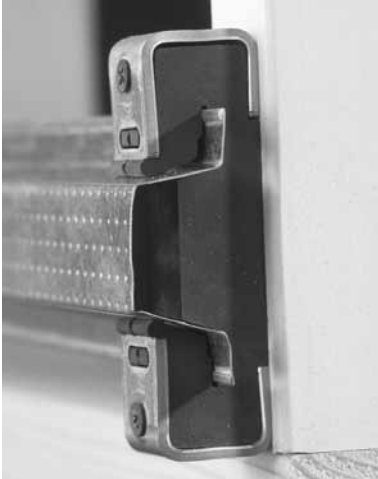

Wall and Ceiling Sound Isolation Theory:

Isolated wall and ceiling systems remain a popular method for mitigating noise problems. Resiliently mounted gypsum board or double wall assemblies are constructed to minimize sound transmission from one occupied space into another. Incorporating Kinetics Noise Control Model IsoMax, designers can create simple, easy to build walls and ceilings that do not require resilient channel, double-wall construction, and/or additional layers of gypsum board. Increasing the air cavity and resiliently decoupling the mass of the gypsum board from the non-isolated structure (e.g., joists, studs, masonry) effectively and economically controls noise transmission.

Application:

Designers wanting low-cost, space saving ceilings and walls that provide superior noise control can employ Kinetics Model IsoMax resilient sound isolation clip. Model IsoMax, attached to ceiling joists, wall studs, or masonry, simply and easily secures drywall furring channel. One or more layers of gypsum board are hung onto the furring channel using common construction practices. Offering higher STC values than drywall attached to resilient

channel, Model IsoMax also ensures that installers will not inadvertently screw through the "resilient" leg of the channel into the joist or stud. Given the frequent occurrences where resilient channel is accidentally rendered ineffective because it is hard-attached, this feature cannot be underestimated when designing and constructing ceilings and walls for noise control.

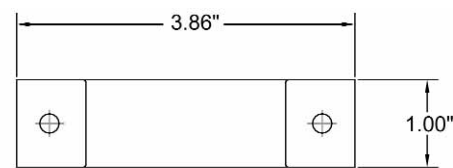

Plan View

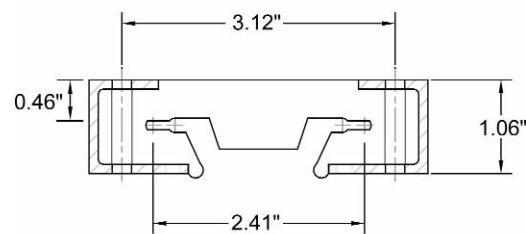

Side View



Resilient Sound Isolation Wall and Ceiling Clip

Model IsoMax

Benefits:

- Highly effective sound control at lowest installed cost.
- Quick and easy to install with standard drywall furring channel.
- Weight capacity - 50 lbs. per clip maximum.
- Maximizes available occupied space with low-profile design.
- Performance range of STC 57 to STC 64 per laboratory tests, a substantial improvement vs. resilient channel.
- Eliminates problem of hard attaching that is common with resilient channel.
- UL fire rated wall and ceiling assemblies are available with IsoMax

Tested Composite Wall Constructions per ASTM E90 and ASTM E413 at Riverbank Labs.

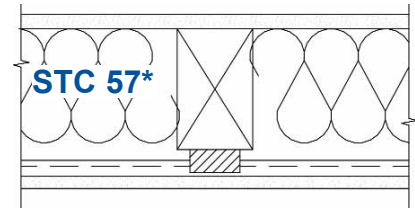

Wood Stud partition, 2 x 4, 16" O.C. with 5/8" gypsum board, one layer each side. R19 fiberglass in cavity. IsoMax clips and 7/8" furring channel.

* **+7 STC improvement** compared to the same wall with resilient channel. Find details in our report; [IsoMax vs RC](#).

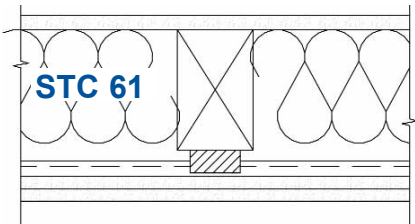

Wood stud partition, 2 x 4, 16" O.C. with 5/8" gypsum board, one layer one side, two layers on opposite side. R19 fiberglass in cavity. IsoMax clips and 7/8" furring channel.

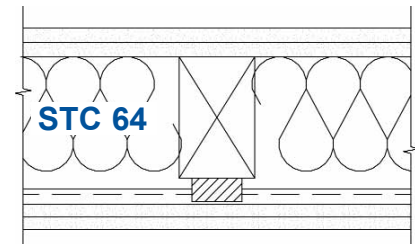

Wood stud partition, 2 x 4, 16" O.C. with 5/8" gypsum board, two layers on each side. R19 fiberglass in cavity. IsoMax clips and 7/8" furring channel.

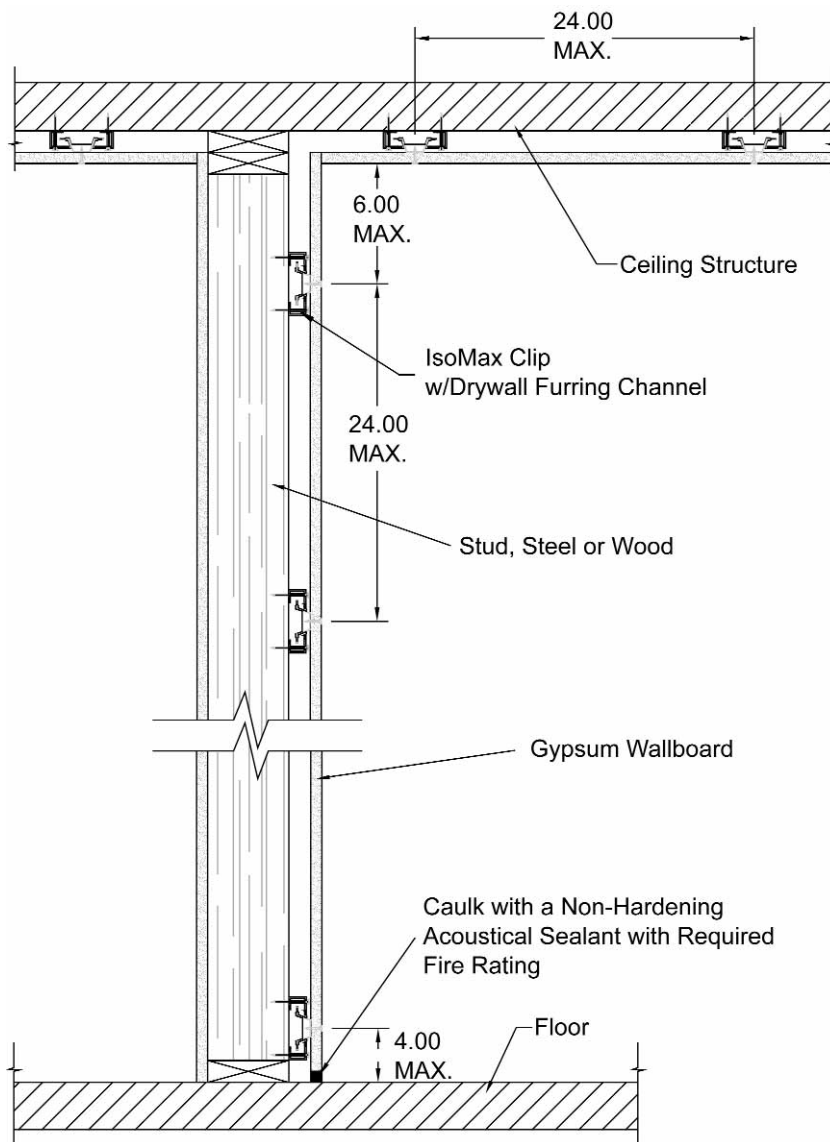

United States	Canada
6300 Ireland Place	1720 Meyerside Drive
P.O. Box 655	Mississauga, Ontario
Dublin, Ohio 43017	L5T 1A3
Phone: 614-889-0480	Phone: 905-670-4922
Fax: 614-889-0540	Fax: 905-670-1698

www.kineticsnoise.com
archsales@kineticsnoise.com

Kinetics Noise Control, Inc. is continually upgrading the quality of our products. We reserve the right to make changes to this and all products without notice.

Download Model IsoMax information including three-part specification, installation guidelines, and typical installation drawings at www.kineticsnoise.com/arch/isomax. Call the factory at 800-959-1229 if needing additional information; ask for Architectural sales.

Purchase Model IsoMax and accessories through your local sales representative (www.kineticsnoise.com/replacement.asp).